



## LEO5

### High-resolution digital manometer

#### Features

- Insulated piezoresistive pressure sensor encapsulated in an oil-filled metal housing
- Robust, watertight stainless steel housing with safety glass front
- Large, backlit LC display
- Integrated rechargeable battery (USB chargeable)
- License-free KELLER software available to download
- Also available as LEO5-BT with integrated Bluetooth interface

#### Functions

- High-resolution pressure measurements
- Pressure peak detection with 5 kHz sampling frequency
- Data logger
- Operated via capacitive touch keys
- Bar graph display
- Temperature display
- Min/max display

#### Typical Applications

- Pressure testing
- Calibration
- Laboratory use
- Industrial applications



#### Accuracy

± 0,05 %FS

#### Total Error Band

± 0,1 %FS

#### Pressure Ranges

-1...3 bar to 0...1000 bar



LEO5 manometer

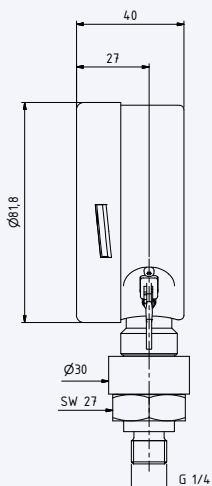

LEO5 with rubber cover

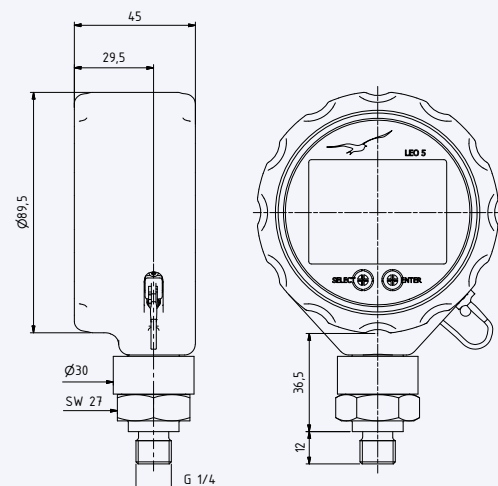



## LEO5 – Specifications

### Standard Pressure Ranges

Gauge pressure, PR	-1...1	-1...3	-1...6	-1...10	-1...16	-1...30								bar rel.
Absolute pressure, PAA	0...2	0...4	0...7	0...11	0...17	0...31	0...61	0...101	0...161					bar abs.
Absolute pressure, PA										0...300	0...400	0...700	0...1000	bar
Overload resistance	8	8	20	20	40	60	200	200	300	600	800	1100	1100	bar
Display resolution	0,0001	0,0001	0,001	0,001	0,001	0,001	0,001	0,01	0,01	0,01	0,02	0,05	0,1	bar

Key	PR	Gauge pressure	Zero at atmospheric pressure
	PAA	Absolute pressure	Zero at 0 bar abs. (vacuum)
	PA	Absolute pressure	Zero at 1 bar abs.

### Performance

Accuracy @ RT (20...25 °C)	$\leq \pm 0,05$ %FS	Nonlinearity (BFSL), pressure hysteresis, non-repeatability, zero point, amplification
Total error band (0...50 °C)	$\leq \pm 0,1$ %FS	Max. deviation within the specified pressure and temperature range
Long-term stability	$\leq \pm 0,1$ %FS	Per year under reference conditions, yearly recalibration recommended
Degree of dependency on location	$\leq \pm 1,5$ mbar	Calibrated in vertical installation position with pressure connection facing downwards
Accuracy of temperature measurement	$\pm 1$ °C typ.	
Pressure range reserve	$\pm 10$ %	
Vacuum endurance	$\leq 0,2$ bar abs.	Of operation $\leq 0,2$ bar abs. upon request

### Temperature Ranges

Compensated temperature range	0...50 °C
Media temperature	-10...60 °C
Ambient temperature	0...50 °C
Storage temperature	-20...70 °C

### Electrical Data

Rechargeable battery	Lithium-ion 4,2 V / 2,3 Ah
Battery life (standard)	Up to 2000 hours of continuous operation
Battery life (peak mode)	Up to 160 hours of continuous operation
Battery charging cycles	> 300
GND case insulation	> 10 M $\Omega$ @ 300 VDC
External interface	USB (KELLER protocol), Bluetooth classic (LEO5-BT)
Interface measuring rate	2 measurements per second
Electrical connection	Mini USB-B
CE conformity as per 2014/30/EU (EMC)	EN 61000-6-1 to -6-4, EN 61326-1 / EN 61326-2-3



## LEO5 – Specifications

### Electrical Data

#### Data logger

Logger function	Records pressure, temperature and measuring time
Data storage	≥ 56 000 measured values
Recording modes	Interval, event-controlled
Measuring rate	≥ 1 second, can be configured in 1-second increments

### Display

Dimensions/appearance	Width × height: 51,3 mm × 38,8 mm, also refer to Dimensions and options
Number of digits on LC display	2 rows with 5 digits each
Display mode	Pressure + min/max or pressure + temperature, additional bar graph
Measuring rate (standard)	2 measurements per second
Measuring rate (peak mode)	5 kHz (reduced resolution and accuracy)
Configurable units of pressure	[bar], [mbar], [Pa], [hPa], [kPa], [MPa], [PSI], [mH <sub>2</sub> O], [cmH <sub>2</sub> O], [inH <sub>2</sub> O], [ftH <sub>2</sub> O], [mmHg], [inHg], [kp/cm <sup>2</sup> ]
Additional units of pressure	5 user-defined units can be configured

### Mechanical Data

#### Materials in contact with media

Pressure connection	Stainless steel AISI 316L
Pressure transducer separating diaphragm	Stainless steel AISI 316L
Pressure transducer seal (internal)	FKM (Viton® type A)
Pressure connection seal (external)	FKM (Viton® type A)

#### Other materials

Display housing	Stainless steel AISI 304
Oil filling pressure transducer	Silicone oil

#### Further details

Pressure connection	G1/4	Other options see available pressure connections
Diameter × height × depth	Approx. 82 mm × 135 mm × 40 mm	Without rubber cover
	Approx. 90 mm × 139 mm × 45 mm	With rubber cover
Weight	Approx. 430 g	
Protection	IP66	



## LEO5 – Dimensions and Options

### LC Display

Front cover	Content	Dimensions
		Width x height: 51,3 mm x 38,8 mm  Digit height: top: 15 mm x 7 mm bottom: 10,5 mm x 4,5 mm

### External Connection

Placement	Mini USB-B connection

### Available Pressure Connections

G1/4 (standard)	G1/2	1/4 NPT	1/2 NPT	G1/2 EN 837
G1/2 flush	G3/4 flush	7/16-20 UNF	Clamp DIN 32676 flush	G1/4 EN 837

Other pressure connections available upon request.

### Optional Advanced Versions

Standard	Detached sensors	Bluetooth interface

### Other Customer-specific Options

- Evaluation on other pressure areas
- Evaluation on other temperature ranges
- Parts that come into contact with media made from Hastelloy, Inconel or titanium
- Customer-specific front covers
- Customer-specific firmware with e.g. application-specific calculations
- Other sealing materials for pressure transducers
- Other oil fillings for pressure transducers



## LEO5 – Software, Scope of Delivery and Accessories

### Interface

The LEO5 manometer has a USB interface. Details of the communication protocols can be found at [www.keller-druck.com](http://www.keller-druck.com). Documentation, a Dynamic Link Library (DLL) and various programming examples are available to integrate the communication protocol into your own software.

### «Logger 5» Software

The Logger 5 software is suitable for the following activities:

- Reading data from the autonomous data collector, e.g. LEO5, and saving to a file on a PC
- Programming and configuring the data logger
- Active reading of the pressure and temperature measured values in one-second intervals and presenting the data in graphs
- Visualising and analysing measurements saved in files
- Printing out reports or saving them as PDF files
- Exporting data and making it available to other applications for further processing
- Performing level measurement calculations

### «CCS30» Software

Recording measured values

- Live visualisation
- Adjustable measuring and storage interval
- Export function

Configuration

- Call up of information (pressure and temperature range, firmware version, serial number etc.)





### “ManoConfig” Software

The ManoConfig program is compatible with various types of KELLER manometers and allows end customers to configure the devices.



Range of functions

- Display of online measured values
- Configuring the wait period before automatic shutdown
- Selecting standard pressure units
- Activating/deactivating pressure units
- Programming user-defined pressure units
- Restoring to factory settings
- Calibrating the manometer

### Scope of Delivery

Plastic case	USB cable	KELLER 5-point report	Operating instructions D/E/F
			

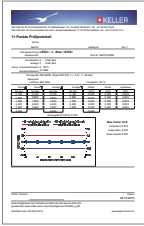
### Accessories

Rubber cover	KELLER 11-point report	Calibration certificate
		
For additional protection in harsh environments	Measurement deviation at room temperature with hysteresis	Issued by the external calibration laboratory of the German accreditation body DAkkS or the Swiss accreditation body SAS